

adaptalift **GROUP**



E-Tech S06-E

**SELF-PROPELLED SCISSOR LIFT
(ELECTRIC DRIVE)**



13 22 54

dingliaustralia.com.au

Dingli E-Tech S06-E

Self-Propelled Scissor Lift (Electric Drive)







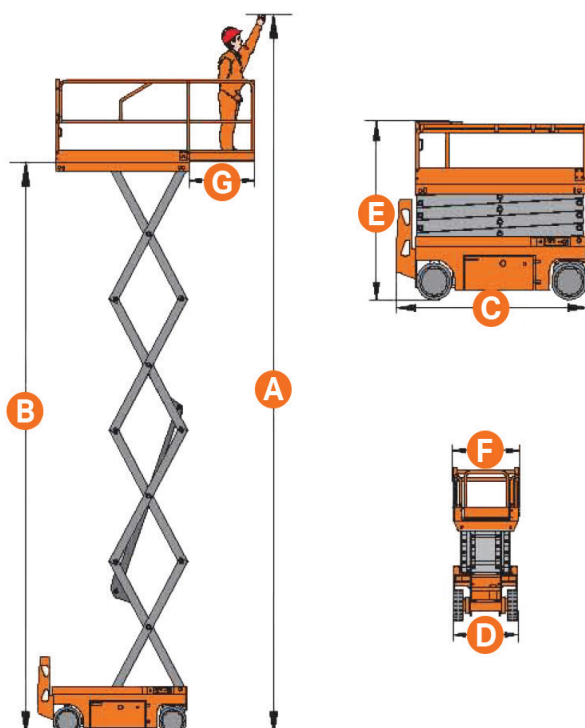

Standard Equipment:

- Proportional controls
- Self-lock gate on platform
- Automatic Pothole Protection
- Drivable at full height
- Onboard diagnostic system
- Non marking tyre
- Automatic brakes system
- Emergency lowering system
- Emergency stop button
- Cylinder holding valve
- Extended platform
- Horn
- Forklift Pockets
- Charger protection
- All motion alarm
- 2WD
- Safety brackets
- Hour meter
- Flashing beacon
- Tilt Sensor with alarm
- Folding Guardrails
- Overload sensor with alarm
- AC Power to platform

Options:

- Platform work lights
- Airline to platform



Specifications		S06-E
	S.W.L	230 kg
	S.W.L On Extension	113 kg
	Max. Occupants (Indoor/Outdoor)	2 / 1
	A Working Height	7.8 m
	B Platform Floor Height	5.8 m
	C Overall Length	1.86 m
	D Overall Width	0.76 m
	Overall Height (Rails Up)	2.18 m
	E Overall Height (Rails Down)	1.84 m
	F Platform Size	1.67 x 0.74 m
	G Platform Extension Size	0.90 m
	Ground Clearance (Stowed)	0.09 m
	Ground Clearance (Raised)	0.019 m
	Wheelbase	1.36 m
	Turning Radius (Inside)	0 m
	Turning Radius (Outside)	1.64 m
	Drive Motors	24 V / 0.5 kW
	Lifting Motor	24 V / 2 kW
	Travel Speed (Stowed)	4.5 km/h
	Travel Speed (Raised)	0.8 km/h
	Up / Down Speed	27 / 22 sec
	Wind Rated	12.5 m/s
	Batteries	4 x 6 V / 210 Ah
	Integrated Charger	24 V / 25 A
	Gradeability	25%
	Maximum Working Slope	1.5° / 3°
	Tyres	ø 305 x 100 mm
	Weight	1,415 kg

* Product specifications and prices are subject to change without notice or obligation. The photographs and/or drawings in this document are for illustrative purposes only.

BRANCHES

VICTORIA

Melbourne - Springvale

- 📍 (Head Office)
1574 Centre Rd,
Springvale, VIC 3171
☎ [03] 9547 8000

Melbourne - Truganina

- 📍 42-44 Jessica Way
Truganina, VIC 3029
☎ [03] 9394 4000

QUEENSLAND

Brisbane (State Office)

- 📍 11 Lombank St,
Acacia Ridge, QLD 4110
☎ [07] 3373 5111

Rockhampton

- 📍 62 Glenmore Rd, Park Avenue,
Rockhampton, QLD 4701
☎ [07] 4922 8874

Townsville

- 📍 39 Duckworth St,
Garbutt, Townsville, QLD 4814
☎ [07] 4778 2000

TASMANIA

Spreyton

- 📍 87a Devonport Rd,
Spreyton, TAS 7310
☎ [03] 6427 3966

NEW SOUTH WALES

Sydney (State Office)

- 📍 219 Newton Rd,
Wetherill Park, NSW 2164
☎ [02] 8788 1777

Riverina

- 📍 5 Favell St,
Griffith, NSW 2680
☎ [02] 6962 7343

SOUTH AUSTRALIA

Adelaide (State Office)

- 📍 18-22 Churchill Rd. Nth.
Dry Creek, SA 5094
☎ [08] 8360 3444

Mt. Gambier

- ☎ 13 22 54

WESTERN AUSTRALIA

Perth (State Office)

- 📍 Unit 1, 1-9 Kurnall Road
Welshpool, WA 6106
☎ [08] 9352 9200

Karratha

- 📍 Lot 3873-Pemberton Rd,
Karratha, WA 6106
☎ 13 22 54